

## TABLE OF CONTENTS

### VINYL-CLAD WINDOWS AND DOORS

800 Double Hung.....	6
800 Casement & Awning .....	8
800 Sliding Patio Door .....	10
800 French Sliding Patio Door.....	12
800 Center Hinged Patio Door.....	14
800 French Hinged Patio Door.....	16

### VINYL WINDOWS AND DOORS

Classic Single Hung .....	18
Classic Double Hung .....	20
Classic Casement & Awning.....	22
Classic Sliding Window.....	24
Classic Sliding Patio Door.....	26

### WOOD & WOOD/COMPOSITE WINDOWS AND DOORS

400 Double Hung.....	28
300 Double Hung.....	30
200 Double Hung.....	32
200 Casement & Awning .....	34
200 Sliding Patio Door .....	36
200 French Sliding Patio Door.....	38
200 Center Hinged Patio Door.....	40

NFRC Thermal Performance Data .....	42
Glass, Screen, Color and Hardware Finish Options .....	44
Grille Style and Patterns, Shapes and Casing Options .....	46



## 800 DOUBLE HUNG

**MW PRO SERIES 800 DOUBLE HUNG** vinyl-clad wood windows make finding the right style and shape simple. They feature natural wood or pre-finished white interiors and are available in singles, twins, combinations, 30° and 45° angle bays, fixed and a variety of architectural shapes.

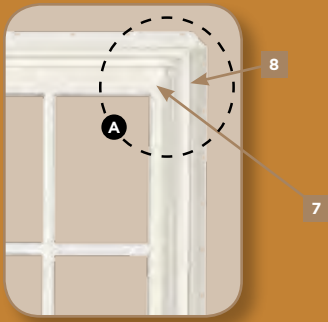

EXTERIOR DETAIL

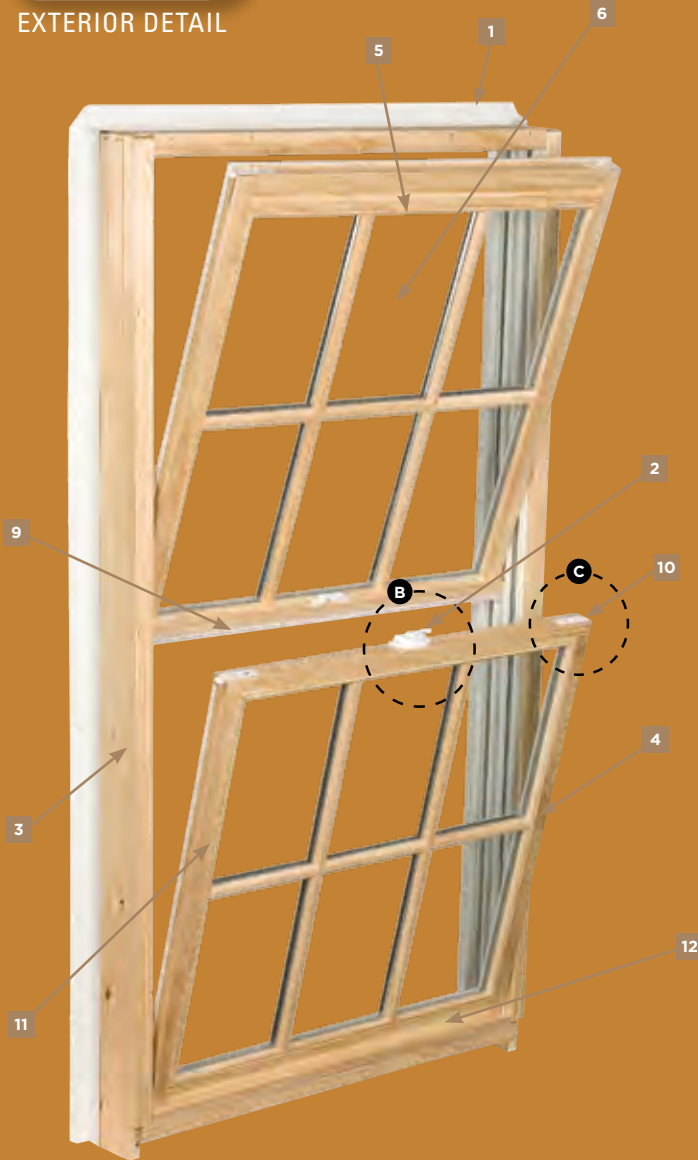

## STANDARD FEATURES

- 1 Pre-punched nailing fin with corner gasket for simple installation
- 2 Cam lock provides security and enhanced performance
- 3 4 9/16" jamb eliminates extensive drywall work
- 4 Both sash tilt in and remove for safe and easy cleaning of exterior glass
- 5 Profiled glazing bead in natural clear wood or cellular PVC for prefinished white to accentuate interior trim
- 6 Energy-efficient warm edge insulating glass
- 7 Rigid form-fitting vinyl cladding on sash and frame, fully welded at top two corners of frame for maximum protection against the elements
- 8 Integral exterior face groove allows for easy mulling
- 9 Weatherstripping on the bottom of each sash and on the window opening form a perimeter seal creating an air and water barrier
- 10 Convenient Easy-Tilt one touch tilt latch makes tilting in sash effortless
- 11 Select clear wood interior ready for paint or stain to match any décor, also available in pre-finished white
- 12 Recessed full-width finger pulls in top and bottom sash for easy operation



Get more beauty for your buck with our 800 double hung units. They come standard with a convenient Easy-Tilt sash system that makes cleaning and maintaining simple. The interior glazed sash design creates shadow lines to help enhance the look and give more curb appeal. Plus, they're available in a variety of grille options including simulated-divided-lite (SDL), grilles-between-the-glass or wood grilles. Each option delivers a traditional look the increases the beauty and enhances the value of your home. Available in white and sandalwood exterior cladding options.

A



Rigid form-fitting vinyl cladding on sash and frame, fully welded at top two corners of frame for maximum protection against the elements

B



Cam lock provides security and enhanced performance

C



Convenient Easy-Tilt one touch tilt latch for easy tilt-in



## 800 CASEMENT & AWNING

**MW PRO SERIES 800 CASEMENT & AWNING** vinyl-clad wood windows are designed around your needs. They are available in singles, twins, triples, quads, combinations, 30° and 45° angle bays, bows and a wide selection of architectural shapes.

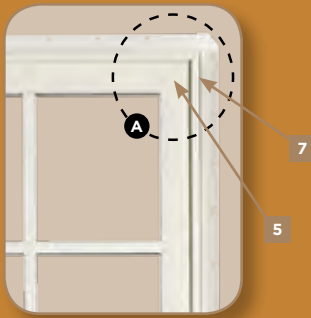

EXTERIOR DETAIL

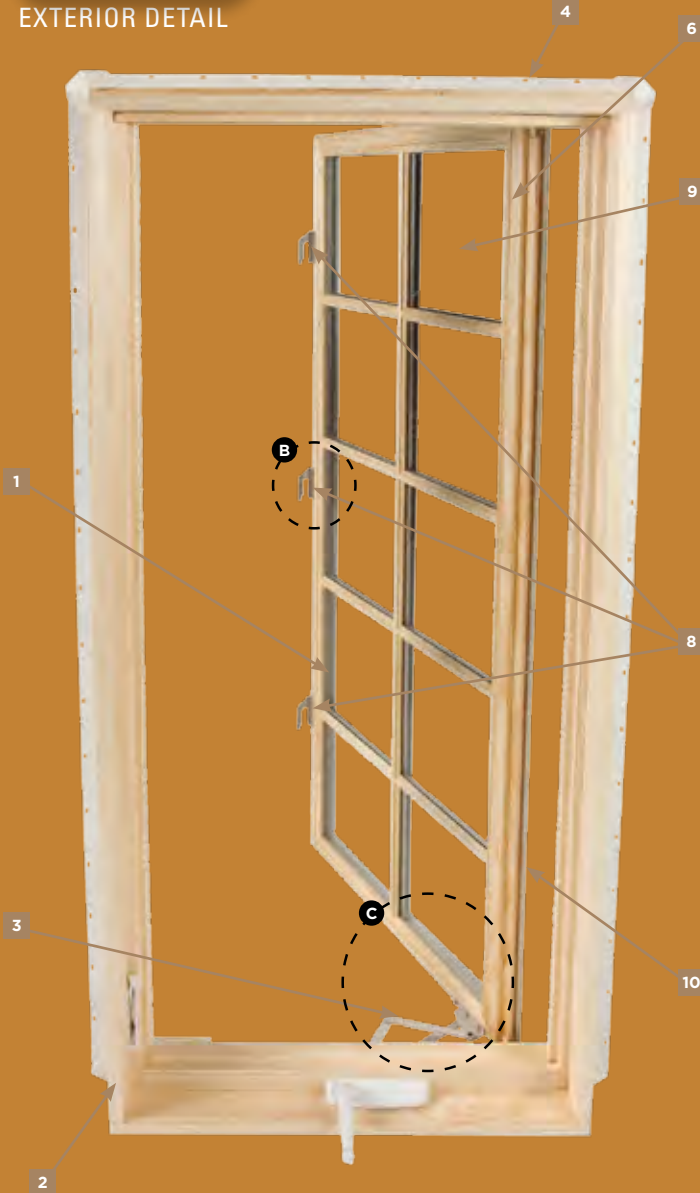

## STANDARD FEATURES

- 1 Profiled glazing bead in natural clear wood or cellular PVC for prefinished white to accentuate interior trim
- 2 4 9/16" jamb made of clear wood eliminates extensive drywall work
- 3 Smooth-functioning operating hardware, concealed for a clean appearance and allowing sash to open a full 90°
- 4 Pre-punched nailing fin for simple and accurate installation
- 5 Rigid form-fitting vinyl cladding on sash and frame, fully welded at all four corners for maximum protection against the elements
- 6 Sash and interior made with select clear wood ready for paint or stain to match any interior décor, also available in pre-finished white
- 7 Integral face groove allows for easy mulling
- 8 Concealed multi-point locking system enhances weather performance and security
- 9 Energy-efficient warm edge insulating glass
- 10 Leaf weatherstripping on sash and bulb weatherstripping on frame for air-tight performance and smooth operation



Bring the beauty and value home with our 800 casement & awning windows. They feature an interior glazed sash to enhance your home's appearance and a weather-resistant stainless steel hinge track and adjustable hinge to ensure superior performance. They're available in a variety of grille options including simulated-divided-lite (SDL), grilles-between-the-glass or wood grilles to help you find a look that matches your home's style. The sash opens a full 90° for simple cleaning. Available in white and sandalwood exterior cladding options.

A



Rigid form-fitting vinyl cladding on sash and frame, fully welded at all four corners for maximum protection against the elements

B

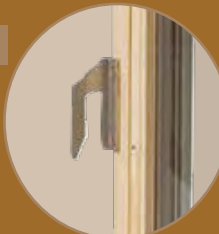

Concealed multi-point locking system enhances weather performance and security

C



Smooth-functioning operating hardware, concealed for a clean appearance and allowing sash to open beyond a full 90°



## 800 SLIDING PATIO DOOR

**MW PRO SERIES 800 SLIDING PATIO DOORS** unlock a world of stylish possibilities. They are available with matching fixed panels, transoms, segmented transoms, circle heads and a wide variety of architectural shapes.



EXTERIOR DETAIL

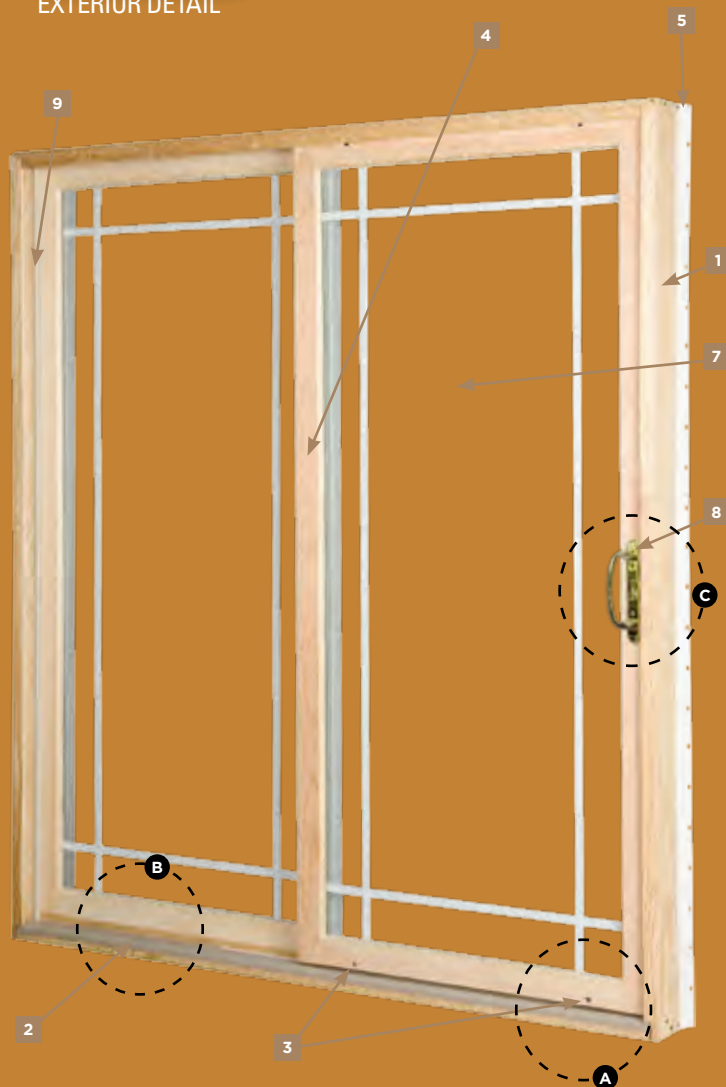

## STANDARD FEATURES

- 1 4 9/16" jambs eliminates extensive drywall work
- 2 Composite sill combines wood, aluminum and vinyl for enhanced durability
- 3 Adjustable rollers ensure smooth operation
- 4 Natural wood interior ready for paint or stain to match any interior décor
- 5 Pre-punched nailing fin with corner gasket for simple installation
- 6 Rigid form-fitting vinyl cladding on door and frame for maximum protection against the elements
- 7 Energy-efficient warm edge insulating tempered glass
- 8 Color-coordinated exterior handle and solid bright brass interior handle
- 9 Full-perimeter weatherstripping for air-tight performance and smooth operation



Looking for more style and more value? Look no further than our 800 sliding doors. They are constructed with full-perimeter weatherstripping for a tight and consistent seal. They're available in a variety of grille options including simulated-divided-lite (SDL), grilles-between-the-glass or wood grilles for a traditional look that fits your home and your style. Choose from a keyed, single point-lock exterior handle available in white, sandalwood or taupe. Then, choose from white and sandalwood low-maintenance, vinyl-clad exterior options. Standard sliding patio doors include a solid bright brass interior handle and a security foot bolt.

A



Adjustable rollers ensure smooth operation

B

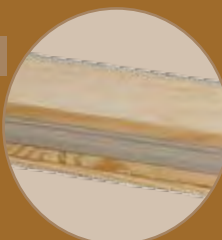

Composite sill combines wood, aluminum and vinyl for enhanced durability

C



Color-coordinated exterior handle and solid bright brass interior handle



## 800 FRENCH SLIDING PATIO DOOR

**MW PRO SERIES 800 FRENCH SLIDING PATIO DOORS** help you bring your vision to life. They are available with matching fixed panels, transoms, segmented transoms and wide selection of architectural shapes.



# 800 FRENCH SLIDING PATIO DOOR



EXTERIOR DETAIL

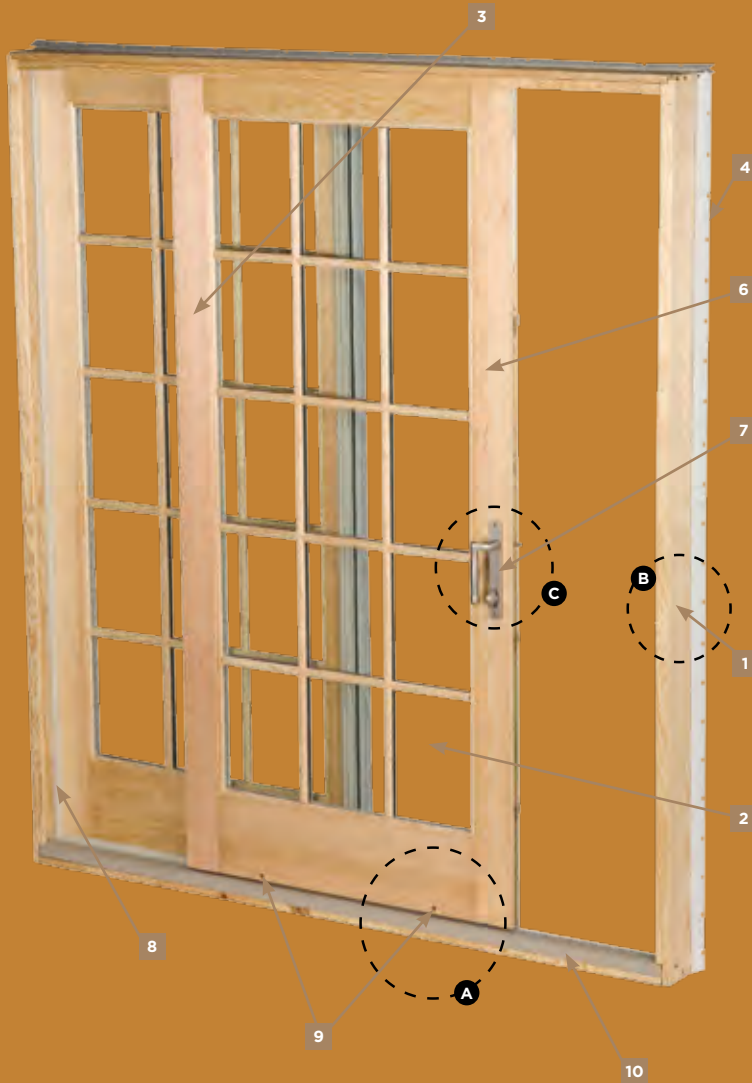

## STANDARD FEATURES

- 1 4 9/16" jambs eliminates extensive drywall work
- 2 Energy-efficient warm edge insulating tempered glass
- 3 Natural wood interior ready for paint or stain to match any interior décor
- 4 Pre-punched nailing fin with corner gasket for simple installation
- 5 Rigid form-fitting vinyl cladding on frame with pultruded fiberglass on door panels for maximum protection against the elements
- 6 1 3/4" panels with wide stiles and rails for a true French look
- 7 Multi-point hardware available in a variety of finishes: bright brass, antique brass, oil rubbed bronze or satin nickel interior and exterior handle sets (satin nickel shown)
- 8 Full-perimeter weatherstripping for air-tight performance and smooth operation
- 9 Adjustable rollers ensures smooth operation
- 10 Composite sill combines wood, aluminum and vinyl for enhanced durability



Make the most of your investment with our 800 French sliding patio doors. They are constructed with full-perimeter weatherstripping for a tight and consistent seal. They're available in a variety of grille options including simulated-divided-lite (SDL), grilles-between-the-glass or wood grilles for a traditional look that fits your home and your style. Choose from handle sets available in solid bright brass, antique brass, oil rubbed bronze or satin nickel finish. Then, choose from white and sandalwood low-maintenance, vinyl-clad exterior options. Standard sliding patio doors include exterior handles with a keyed multi-point lock. A security foot bolt is also available.

A

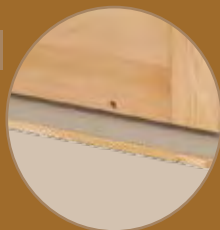

Adjustable rollers ensure smooth operation

B



4 9/16" jambs eliminates extensive drywall work

C



Solid bright brass, antique brass, oil rubbed bronze or satin nickel interior and exterior handle sets (satin nickel shown)



## 800 CENTER HINGED PATIO DOOR

**MW PRO SERIES 800 CENTER HINGED PATIO DOORS** are always in style. Choose from a variety of options including matching fixed panels, transoms, segmented transoms as well as a variety of unique architectural shapes.

# 800 CENTER HINGED PATIO DOOR



EXTERIOR DETAIL



## STANDARD FEATURES

- 1 Pre-punched nailing fin with corner gasket for simple installation
- 2 Full-perimeter weatherstripping for air-tight performance and smooth operation
- 3 4 <sup>9</sup>/<sub>16</sub>" jambos eliminates extensive drywall work
- 4 Prepared for handle hardware with your choice of multi-point, deadbolt, or single bore; handle hardware available in a variety of finishes: bright brass, antique brass, oil rubbed bronze or satin nickel interior and exterior handle sets (satin nickel shown)
- 5 Rigid form-fitting vinyl cladding on frame with pultruded fiberglass on door panels for maximum protection against the elements
- 6 Natural wood interior ready for paint or stain to match any interior décor
- 7 Energy-efficient warm edge insulating tempered glass
- 8 Composite sill combines wood, aluminum and vinyl for enhanced durability



Discover a door that's centered around value and quality. Our 800 center hinged patio doors are constructed with full-perimeter weatherstripping for a tight and consistent seal. They're available in a variety of grille options including simulated-divided-lite (SDL), grilles-between-the-glass or wood grilles for a traditional look that fits your home and your style. Choose from multi-point handle sets available in solid bright brass, antique brass, oil rubbed bronze or satin nickel finish. Select from a variety of door configurations including no bore, dead bolt bore or multi-point bore. Then, choose from white and sandalwood low-maintenance, vinyl-clad exterior options.



**A** Handle sets also come in solid bright brass, antique brass, or oil rubbed bronze with matching hinge and strike



**B** Composite sill, combines wood, aluminum and vinyl for enhanced durability



## 800 FRENCH HINGED PATIO DOOR

**MW PRO SERIES 800 FRENCH HINGED PATIO DOORS** are open to your own unique style. That's because they're available in a variety of options including matching fixed panels, transoms, segmented transoms and a wide variety of architectural shapes.

# 800 FRENCH HINGED PATIO DOOR

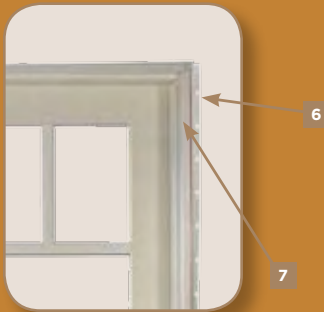

EXTERIOR DETAIL



## STANDARD FEATURES

- 1 1 3/4" panels with wide stiles and rails for a true French look
- 2 Natural wood interior ready for paint or stain to match any interior décor
- 3 Energy-efficient warm edge insulating tempered glass
- 4 Full-perimeter weatherstripping for air-tight performance and smooth operation
- 5 Prepared for handle hardware with your choice of multi-point, deadbolt, or single bore; handle hardware available in a variety of finishes: bright brass, antique brass, oil rubbed bronze or satin nickel interior and exterior handle sets (satin nickel shown)
- 6 Pre-punched nailing fin with corner gasket for simple installation
- 7 Rigid form-fitting vinyl cladding on frame with pultruded fiberglass on door panels for maximum protection against the elements
- 8 4 9/16" jambs eliminates extensive drywall work
- 9 Composite sill combines wood, aluminum and vinyl for enhanced durability



Our 800 French hinged patio doors provide looks and value that lasts. They are constructed with full-perimeter weatherstripping for a tight and consistent seal. They're available in a variety of grille options including simulated-divided-lite (SDL), grilles-between-the-glass or wood grilles for a traditional look that fits your home and your style. Choose from handle sets available in solid bright brass, antique brass, oil rubbed bronze or satin nickel finish. Then, choose from white and sandalwood low-maintenance, vinyl-clad exterior options. Standard sliding patio doors include exterior handles with a keyed multi-point lock.

A



Full-perimeter weatherstripping for air-tight performance and smooth operation

B

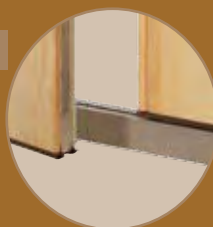

Composite sill combines wood, aluminum and vinyl for enhanced durability

C



Solid bright brass, antique brass, oil rubbed bronze or satin nickel interior and exterior handle sets with matching hinge and strike



## CLASSIC SINGLE HUNG

**MW PRO SERIES CLASSIC SINGLE HUNG** windows were built to match the unique looks of your home. Constructed with a traditional brick mould exterior, they are available in singles, twins, triples, operating true radius, operating arch, operating uneven leg arch, combinations, 30° and 45° angle bays, fixed and a wide selection of architectural shapes.

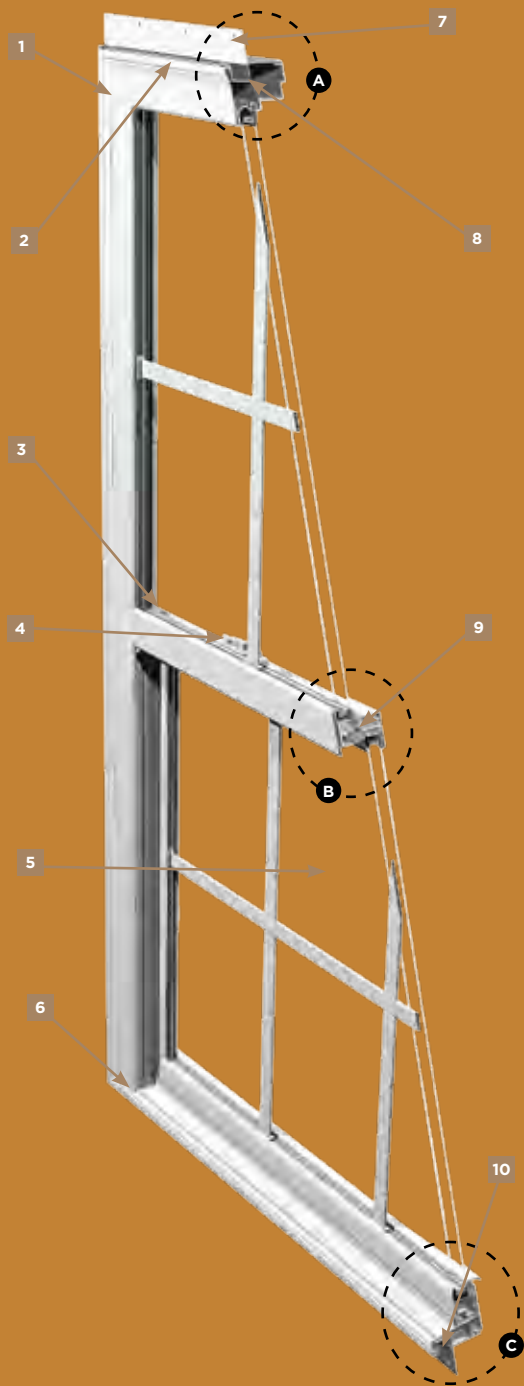

## STANDARD FEATURES

- 1 Classic brick mould profile provides an authentic sculptured appearance that matches traditional exterior millwork
- 2 Interior and exterior accessory grooves allow for easy accessory application
- 3 Bottom sash tilts in and removes for safe and easy cleaning of exterior glass
- 4 Weather-tight dual action sash lock provides security while sealing out the weather and sealing in your comfort
- 5 Energy-efficient warm edge insulating glass for enhanced energy efficiency
- 6 Low-profile sill nosing resembles a traditional wood window
- 7 Integral nailing fin with welded corners for simple and accurate installation
- 8 Maintenance-free multi-chamber PVC construction with fusion welded corners for durability, weather-tight performance and beauty
- 9 Robust interlock satisfies forced entry requirements and improves structural performance
- 10 Integral  $\frac{1}{16}$ " siding pocket with undersill trim leg allows for simple and secure siding installation



Maximize the performance and the value with our Classic vinyl single hung windows. Twin and triple units can be ordered in an integral mull design with a continuous head and sill for a cleaner appearance. Choose from a variety of shapes including operating true radius, operating arch and operating uneven leg arch.



**A** Maintenance-free multi-chamber PVC construction with fusion welded corners for durability and weather-tight performance



**B** Robust interlock satisfies forced entry requirements and improves structural performance

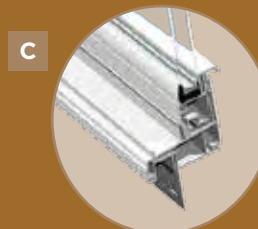

**C** Integral  $\frac{1}{16}$ " siding pocket with undersill trim leg allows for simple and secure siding installation

1. Available option. 2. HP glass option combines Low-E with argon gas fill for high performance. 3. Most units are rated DP50 straight out of the box. 4. Impact Rated units are available in select sizes and configurations.



## CLASSIC DOUBLE HUNG

**MW PRO SERIES CLASSIC DOUBLE HUNG** windows help reflect your own personal style. Constructed with a traditional brick mould exterior, they are available in singles, twins, triples, combinations, 30° and 45° angle bays, fixed and a wide selection of architectural shapes.



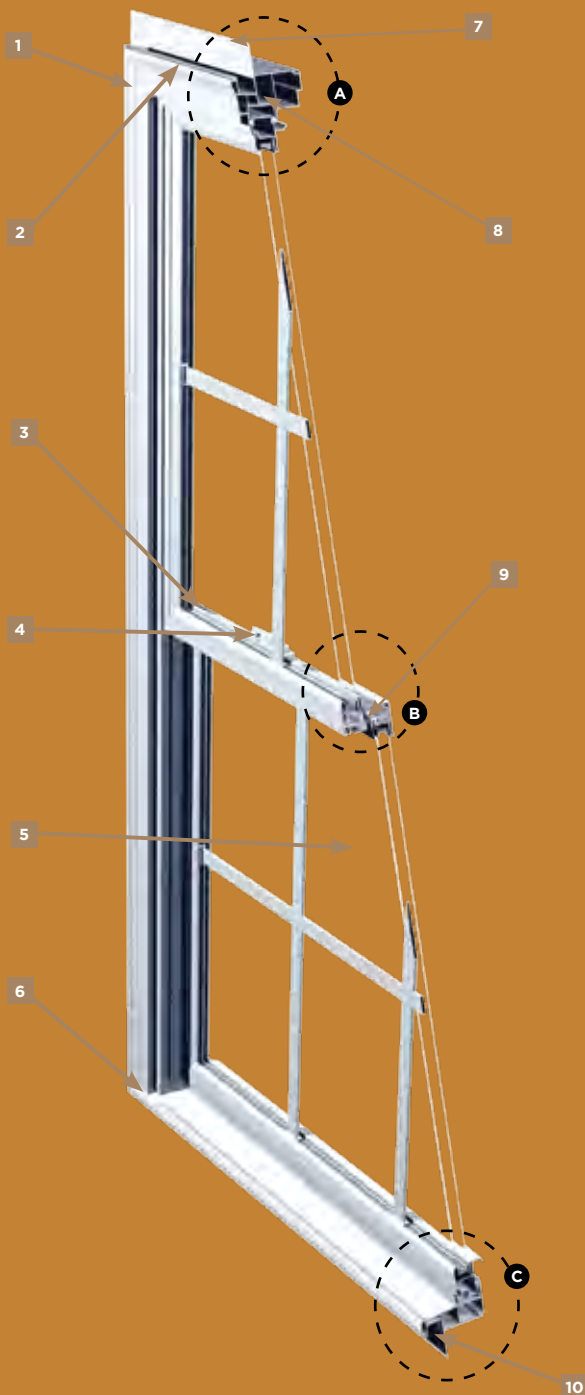

## STANDARD FEATURES

- 1 Classic brick mould profile provides an authentic sculptured appearance that matches traditional exterior millwork
- 2 Interior and exterior accessory grooves allow for easy accessory application
- 3 Both sash tilt in and remove for safe and easy cleaning of exterior glass
- 4 Weather-tight dual action sash lock provides security while sealing out the weather and sealing in your comfort
- 5 Energy-efficient warm edge insulating glass for enhanced energy efficiency
- 6 Low-profile sill nosing resembles a traditional wood window
- 7 Integral nailing fin with welded corners for simple and accurate installation
- 8 Maintenance-free multi-chamber PVC construction with fusion welded corners for durability, weather-tight performance and beauty
- 9 Robust interlock satisfies forced entry requirements and improves structural performance
- 10 Integral  $\frac{1}{16}$ " siding pocket with undersill trim leg allows for simple and secure siding installation



Our Classic vinyl double hung windows are taking quality and value to a whole new level. They come with a convenient tilting sash system that allows for easy cleaning. Integral mulls are available on twin and triple units providing a continuous head and sill for a sleeker appearance and enhanced performance.

A



Maintenance-free multi-chamber PVC construction with fully welded corners for durability and weather-tight performance

B



Robust interlock satisfies forced entry requirements and improves structural performance

C



Integral  $\frac{1}{16}$ " siding pocket with undersill trim leg allows for simple and secure siding installation



## CLASSIC CASEMENT & AWNING

**MW PRO SERIES CLASSIC CASEMENT & AWNING** windows are available in singles, twins, triples, side lites, fixed, combinations, 30° and 45° angle bays, 4 and 5 unit bows and a wide variety of architectural shapes.

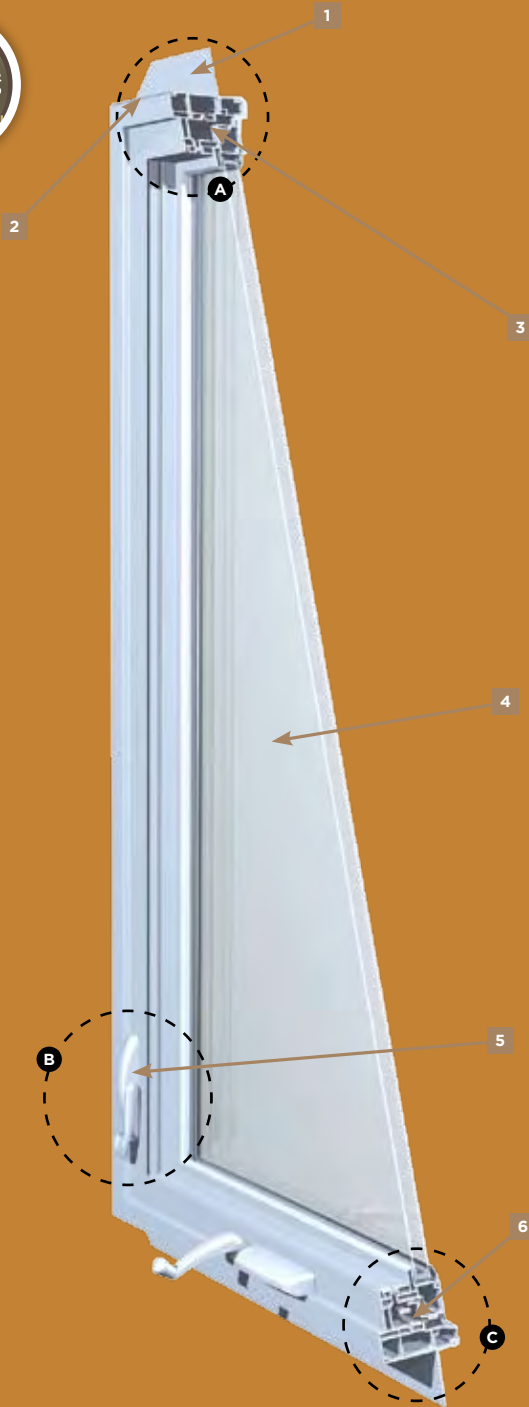

## STANDARD FEATURES

- 1 Integral nailing fin with welded corners for simple and accurate installation
- 2 Interior and exterior accessory grooves for easy accessory application
- 3 Maintenance-free multi-chamber PVC construction with fusion welded corners for durability, weather-tight performance and beauty
- 4 Energy-efficient warm edge insulating glass for enhanced energy efficiency
- 5 Single-handle multi-point locking system so you can easily secure your windows in one operation
- 6 Split-arm gear operator for call sizes up to 3050 and dual-arm gear operator on larger units to ensure smooth operation when opening and closing your windows



Make your view one-of-a-kind with Classic casement & awning windows. They feature a weather-resistant stainless steel hinge track and an adjustable hinge to ensure smooth, precise operation. The sash opens a full 90° to make cleaning easy. Select from our field applied snap-on exterior brick mould, field applied snap-on stucco fin, coastal hardware and expanded access hardware.



**A** Maintenance-free multi-chamber PVC construction with fully welded corners for durability and weather-tight performance



**B** Single-handle multi-point locking system so you can easily secure your windows in one operation

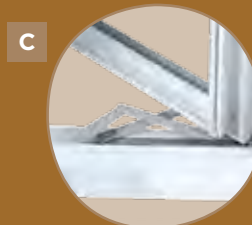

**C** Split-arm gear operator to ensure smooth operation when opening and closing your windows

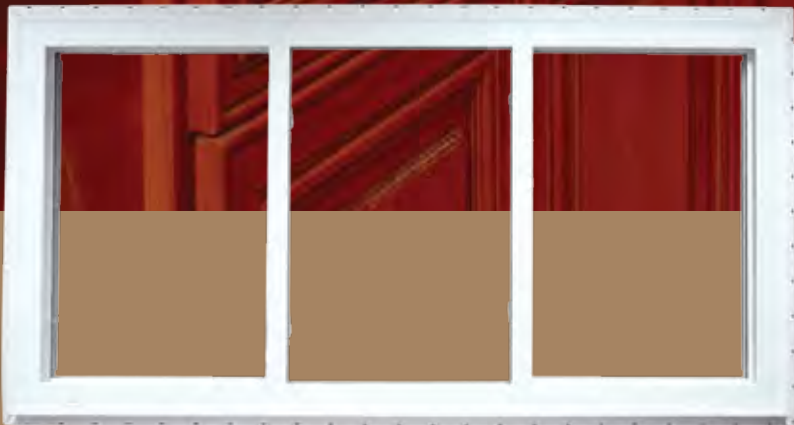

## CLASSIC SLIDING WINDOW

**MW PRO SERIES CLASSIC SLIDING WINDOWS** are easy to operate and hard to miss. They are available in two different picture configurations ( $\frac{1}{4}$ - $\frac{1}{2}$ - $\frac{1}{4}$  or  $\frac{1}{3}$ - $\frac{1}{3}$ - $\frac{1}{3}$ ).

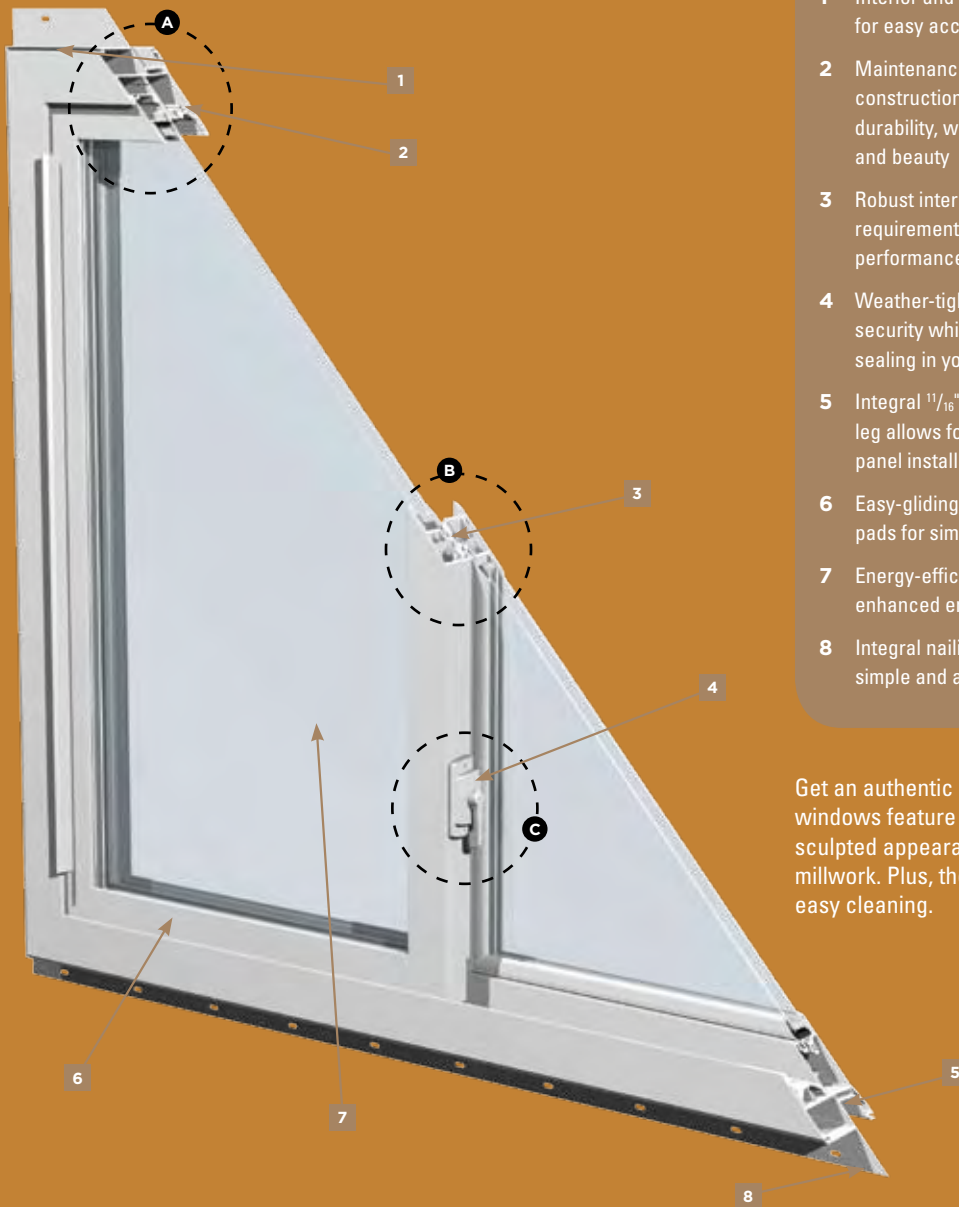

## STANDARD FEATURES

- 1 Interior and exterior accessory grooves allow for easy accessory application
- 2 Maintenance-free multi-chamber PVC construction with fusion welded corners for durability, weather-tight performance and beauty
- 3 Robust interlock satisfies forced entry requirements and improves structural performance
- 4 Weather-tight dual action sash lock provides security while sealing out the weather and sealing in your comfort
- 5 Integral  $\frac{1}{16}$ " siding pocket with undersill trim leg allows for simple and secure siding panel installation
- 6 Easy-gliding lift-out sash with durable nylon pads for simple cleaning and smooth operation
- 7 Energy-efficient warm edge insulating glass for enhanced energy efficiency
- 8 Integral nailing fin with welded corners for simple and accurate installation



Get an authentic look at a classic value. Our Classic sliding windows feature brick mould exteriors for an authentic sculpted appearance that matches traditional exterior millwork. Plus, they have convenient lift-out sashes for easy cleaning.

A



Maintenance-free multi-chamber PVC construction with fully welded corners for durability and weather-tight performance

B



Robust interlock satisfies forced entry requirements and improves structural performance

C



Weather-tight dual action sash lock provides security while sealing out the weather and sealing in your comfort



## CLASSIC SLIDING PATIO DOOR

**MW PRO SERIES CLASSIC SLIDING PATIO DOORS** invite the style in. They are available with matching fixed panels, side lites, transoms and segmented transoms.

# CLASSIC SLIDING PATIO DOOR

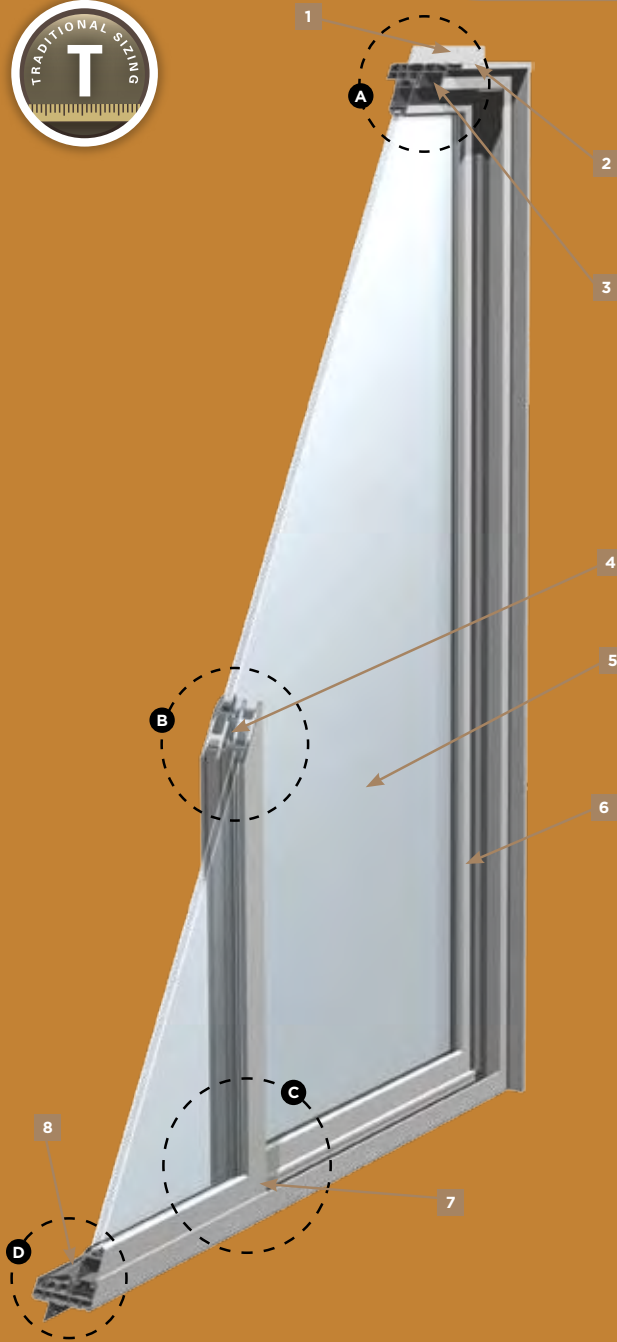

## STANDARD FEATURES

- 1 Pre-punched nailing fin with fusion welded corners for simple and accurate installation
- 2 Interior and exterior accessory groove for drywall return, extension jamb and exterior brick mould application
- 3 Maintenance-free multi-chamber PVC construction with fully welded corners for weather-tight performance
- 4 Self-centering interlock satisfies forced entry requirements
- 5 Energy-efficient warm edge insulating tempered glass for enhanced energy efficiency
- 6 Field reversible panels for simple on-site conversions (8-0 height is not reversible)
- 7 Simple roller adjustment access through end of panel ensures smooth operation
- 8 Aluminum threshold and sill track for enhanced durability

One door opens up all kinds of possibilities. Our classic sliding patio doors feature a unique design that allows for simple field reversibility before or even after installation. They are constructed with full-perimeter weatherstripping for a tight and consistent seal. Choose exterior handles with or without a keyed lock. Plus, you can pick from a variety of optional features including an ADA compliance kit with handle and ramps, snap-on exterior brick mould (field-applied) and coastal hardware.



**A** Maintenance-free multi-chamber PVC construction with fully welded corners for weather-tight performance



**B** Self-centering interlock satisfies forced entry requirements



**C** Simple roller adjustment access through end of panel ensures smooth operation



**D** Aluminum threshold and sill track

1. Available option. 2. HP glass option combines Low-E with argon gas fill for high performance. 3. Most units are rated DP50 straight out of the box. 4. Impact Rated units are available in select sizes and configurations.



## 400 DOUBLE HUNG

**MW PRO SERIES 400 DOUBLE HUNG** wood/composite windows bring out the beauty in any home. They feature paintable sash, sill and exterior components with the traditional look of wood and the weather-resistant benefits of cellular PVC. Choose from singles, twins, combinations, 30° and 45° angle bays, side lites, fixed and a wide selection of architectural shapes.



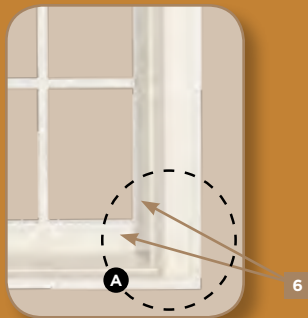

EXTERIOR DETAIL

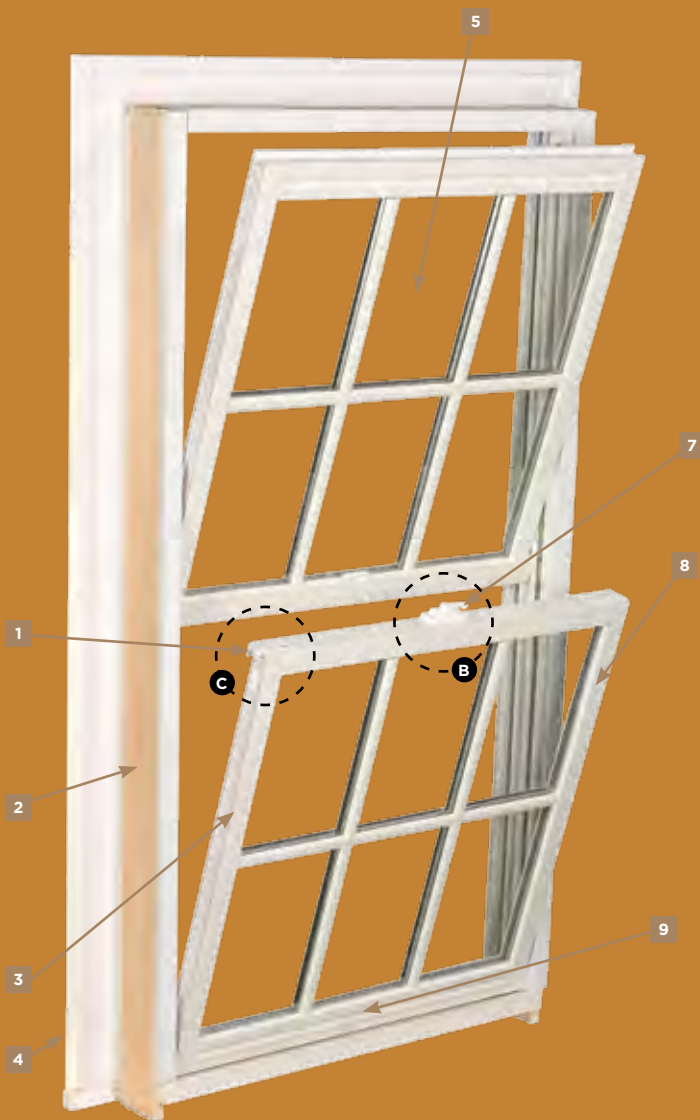

## STANDARD FEATURES

- 1 Robust interlock design for enhanced structural performance
- 2 4 9/16" jamb eliminates extensive drywall work
- 3 With standard compression balance system both sash tilt in and remove for safe and easy cleaning of exterior glass
- 4 Low-maintenance cellular PVC exterior components and brick mould ready to accept acrylic latex paints
- 5 Energy-efficient warm edge insulating glass
- 6 Traditional wood designed stile and rail construction
- 7 Cam lock provides security and enhanced performance
- 8 Sash made from low-maintenance cellular PVC components ready to accept acrylic latex paints
- 9 Foam-filled bulb weatherstripping on bottom rail creates an efficient weather barrier



The style. The features. The value. Our 400 double hung wood/composite units feature sash and exterior components made from low-maintenance cellular PVC to help increase performance and resist rot. They are optionally configured with our Easy-Tilt sash system, which makes cleaning your windows virtually effortless. Our selection of exterior casing options and simulated-divided-lite (SDL) provide a historically accurate look to help enhance the beauty of your home.



**A** Traditional wood designed stile and rail construction



**B** Cam lock provides security and enhanced performance



**C** Robust interlock design for enhanced structural performance



## 300 DOUBLE HUNG

**MW PRO SERIES 300 DOUBLE HUNG** wood/composite windows combine durability with flexibility. They have an all vinyl sash that offers superior performance. Plus, they are available in singles, twins, combinations, 30° and 45° angle bays, side lites, fixed and a wide variety of architectural shapes.

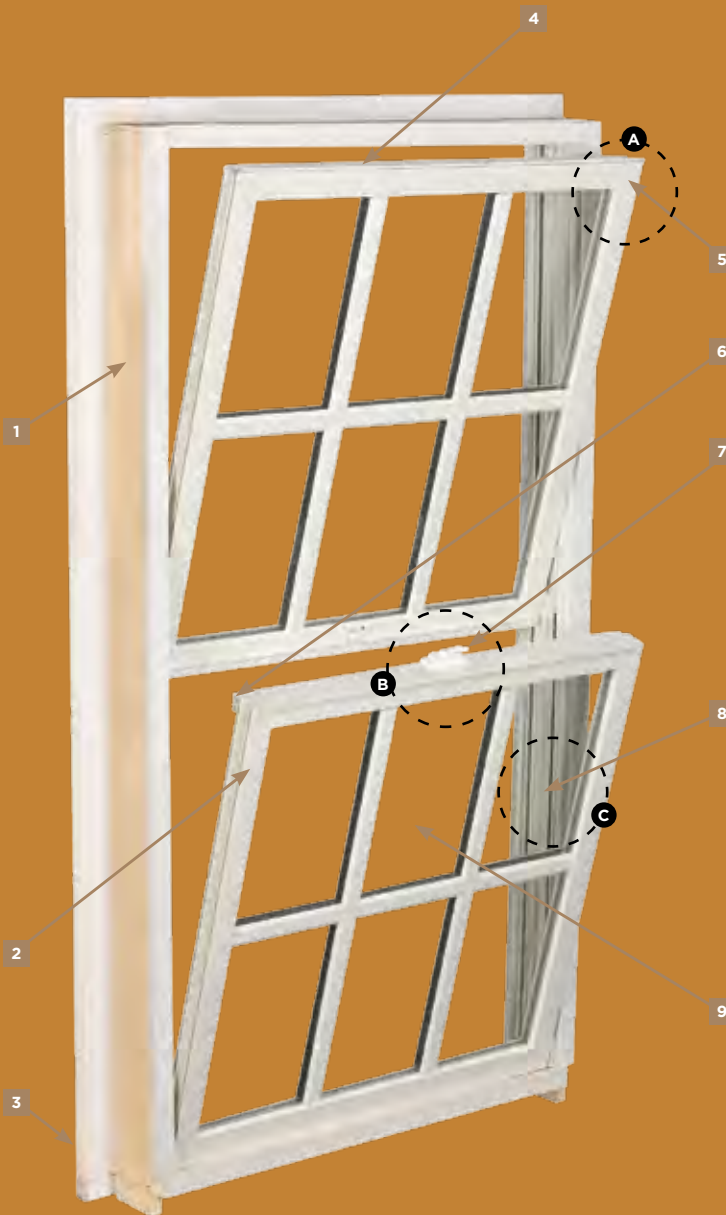

## STANDARD FEATURES

- 1 4 9/16" jamb eliminates extensive drywall work
- 2 Both sash tilt in and remove for safe and easy cleaning of exterior glass
- 3 Low-maintenance cellular PVC exterior components and brick mould ready to accept acrylic latex paints
- 4 Bulb weather-stripping at top, bottom and pile weatherstripping at check rails for efficient performance and smooth, easy operation.
- 5 Paint-free all-vinyl sash fusion welded at the corners
- 6 Robust interlock design for enhanced structural performance
- 7 Dual action sash lock provides security and enhanced performance
- 8 Balances counter-balanced with quiet, adjustable springs for smooth up and down action
- 9 Energy-efficient warm edge insulating glass



Add durability and beauty to any home with our 300 double hung units. They feature paint-free all vinyl sashes for increased performance and convenience. And, when you upgrade to our more convenient Easy-Tilt sash system, cleaning your windows will be easier than ever. Our selection of exterior casing options and simulated-divided-lite (SDL) provide a historically accurate look to help enhance the beauty of your home.

A



Paint-free all-vinyl sash fully welded at the corners

B



Dual action sash lock provides security and enhanced performance

C



Balances counter-balanced with quiet, adjustable springs for smooth up and down action



## 200 DOUBLE HUNG

**MW PRO SERIES 200 DOUBLE HUNG** wood/composite windows combine historical looks with modern features. They're available in singles, twins, combinations, 30° and 45° angle bays, side lites, fixed and a wide selection of architectural shapes.

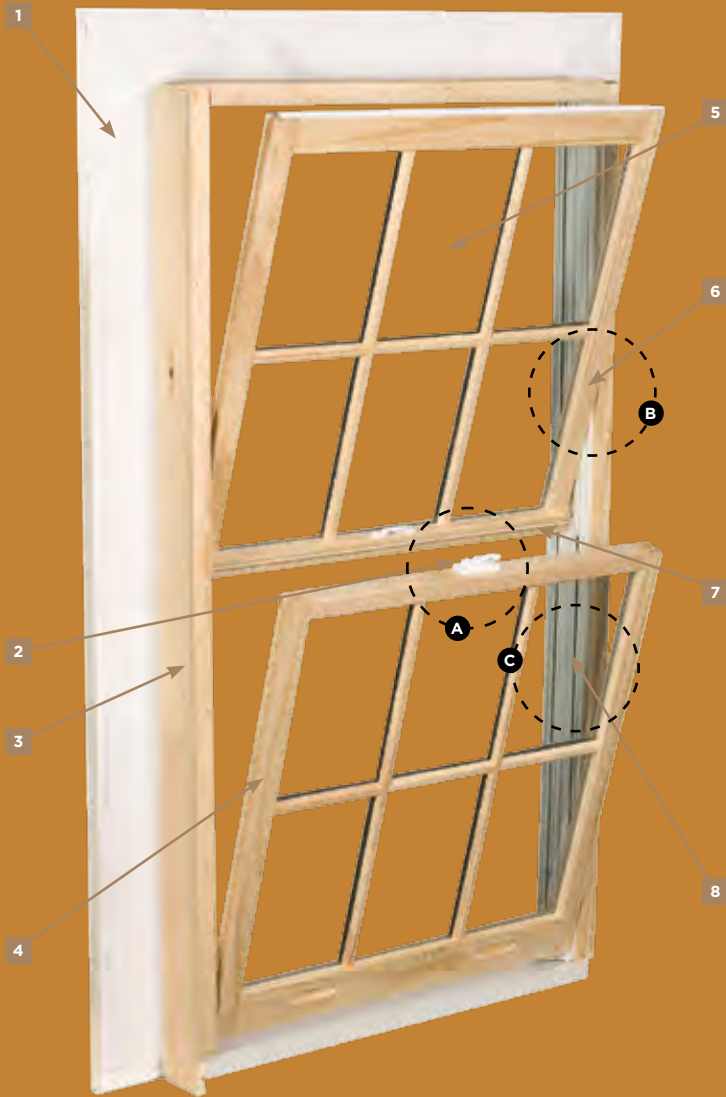

## STANDARD FEATURES

- 1 Low-maintenance cellular PVC exterior casing and brick mould ready to accept acrylic paint
- 2 Cam action sash locks with matching white jambliner
- 3 4 <sup>9</sup>/<sub>16</sub>" jambs eliminates extensive drywall work
- 4 Both sash tilt in and remove for safe and easy cleaning of exterior glass
- 5 Energy-efficient warm edge insulating glass
- 6 Sash and interior made with select clear wood ready for staining to match any interior décor – also available with primed interior for painting
- 7 Bulb weatherstripping on sash for air-tight performance and smooth operation
- 8 Compression balance system for simple tilt-in cleaning of exterior glass



Style comes standard with all of our 200 double hung wood/composite windows. They are equipped with a tilt-in sash system that makes cleaning simple. The low-maintenance cellular PVC exterior components and brick mould resist rot and can easily be painted. A selection of exterior casing options and simulated- divided-lite (SDL) provide a historically accurate look to help enhance the beauty of your home.

**A**



Low-maintenance no-rot cellular PVC exterior casing and brick mould primed and ready to accept acrylic paint

**B**

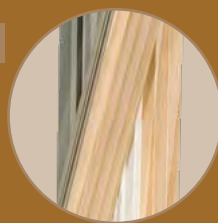

Sash and interior made with select clear wood ready for paint or stain to match any interior décor

**C**



Compression balance system for simple tilt-in cleaning of exterior glass



## 200 CASEMENT & AWNING

**MW PRO SERIES 200 CASEMENT & AWNING** wood/composite windows combine modern features with historical appeal. Choose from singles, twins, combinations, 30° and 45° angle bays, side lites, fixed and a wide selection of architectural shapes.

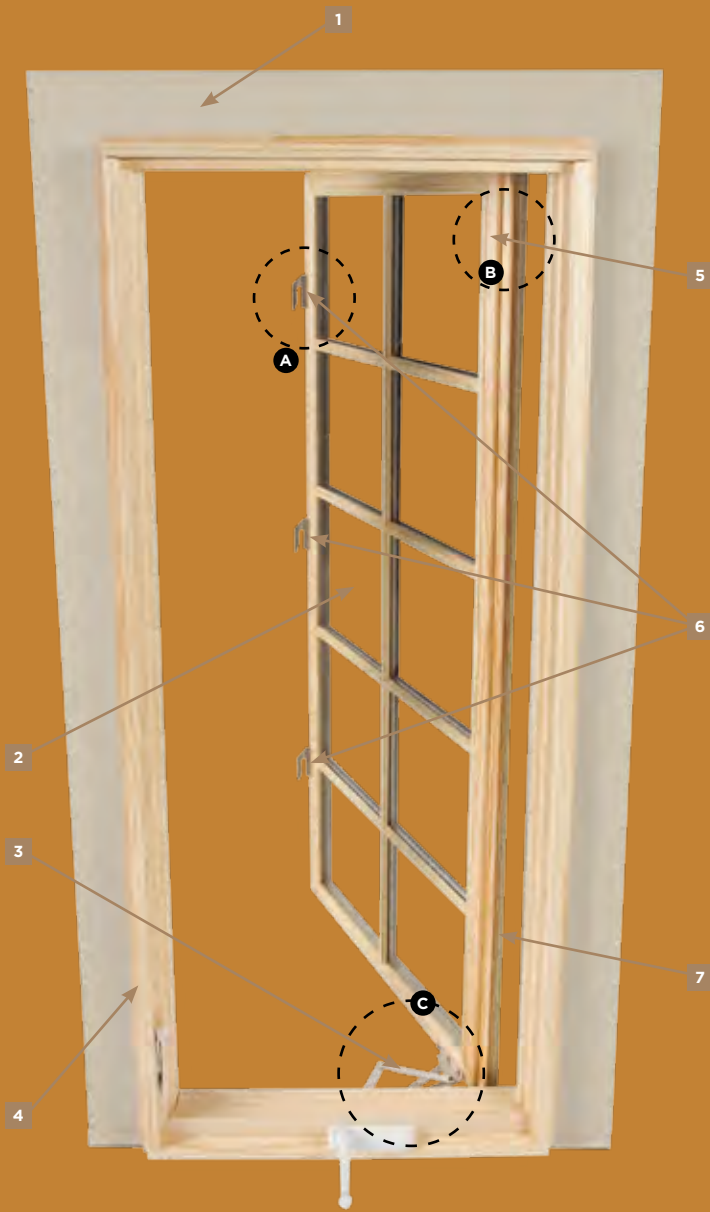

## STANDARD FEATURES

- 1 Low-maintenance cellular PVC exterior and brick mould ready to accept acrylic latex paints
- 2 Energy-efficient warm edge insulating glass
- 3 Smooth-functioning operating hardware, concealed for a clean appearance and allowing sash to open beyond a full 90°
- 4 4 9/16" jambs eliminates extensive drywall work
- 5 Sash and interior made with select clear wood ready for staining to match any interior décor – also available with primed interior for painting
- 6 Concealed multi-point locking system, enhancing weather performance and security
- 7 Leaf weatherstripping on sash and bulb weatherstripping on frame for air-tight performance and smooth operation



Don't just add looks; add value with our 200 casement & awning wood/composite windows. They feature a weather-resistant stainless steel hinge track and an adjustable hinge that ensures consistent and precise operation. The sash opens a full 90° for simple cleaning. Low-maintenance cellular PVC exterior components and brick mould help resist rot and are ready to be painted. A selection of exterior cladding options and simulated-divided-lite (SDL) provide a historically accurate look to help enhance the beauty of your home.



**A** Concealed multi-point locking system, enhancing weather performance and security



**B** Sash and interior made with select clear wood ready for paint or stain to match any interior décor



**C** Smooth-functioning operating hardware, concealed for a clean appearance and allowing sash to open beyond a full 90°



## 200 SLIDING PATIO DOOR

**MW PRO SERIES 200 SLIDING PATIO DOORS** are equipped with all the right looks and all the right features. They are available with matching side lites, fixed panels, transoms, segmented transoms and a variety of architectural shapes.





## STANDARD FEATURES

- 1 Full-perimeter weatherstripping for air-tight performance and smooth operation
- 2 Low-maintenance cellular PVC exterior brick mould with water-repellent preservative treated wood components are ready for acrylic latex paints
- 3 Natural wood ready for staining to match any interior décor – also available with primed interior for painting
- 4 4 <sup>9</sup>/<sub>16</sub>" jambs eliminates extensive drywall work
- 5 Energy-efficient warm edge insulating tempered glass
- 6 Adjustable rollers ensure smooth operation
- 7 Composite sill, combines wood, aluminum and vinyl for enhanced durability
- 8 Metal exterior handle with wood trim interior handle



Take your home's value up a notch with our 200 sliding patio doors. They feature a low-maintenance cellular PVC brick mould and water-repellent wood preservative treated exterior components that are ready to be painted. They are constructed with full-perimeter weatherstripping for a tight and consistent seal. Exterior handles are available with or without a keyed lock. A selection of exterior casing options and simulated-divided-lite (SDL) provide a historically accurate look to help enhance the beauty of your home.

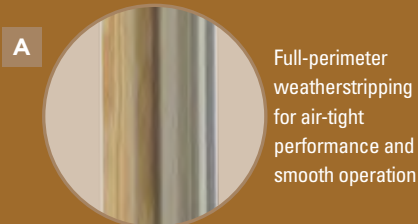

**A** Full-perimeter weatherstripping for air-tight performance and smooth operation



**B** Adjustable rollers ensure smooth operation



**C** 4 <sup>9</sup>/<sub>16</sub>" jambs eliminates extensive drywall work



## 200 FRENCH SLIDING PATIO DOOR

**MW PRO SERIES 200 FRENCH SLIDING PATIO DOORS** are as inviting as it gets with low-maintenance features and stunning looks. Choose from matching side lites, fixed panels, transoms, segmented transoms and a variety of architectural shapes.



## STANDARD FEATURES

- 1 Energy-efficient warm edge insulating tempered glass
- 2 Low-maintenance cellular PVC exterior brick mould with water-repellent preservative treated wood components are ready for acrylic latex paints
- 3 Vinyl-wrapped foam-filled full-perimeter weatherstripping for air-tight performance and smooth operation
- 4 Natural wood ready for staining to match any interior décor – also available with primed interior for painting
- 5 Multipoint hardware available in a variety of finishes: bright brass, antique brass, oil rubbed bronze or satin nickel interior and exterior handle sets (satin nickel shown)
- 6 4 9/16" jambs eliminates extensive drywall work
- 7 Composite sill combines wood, aluminum and vinyl for enhanced durability
- 8 Adjustable rollers ensure smooth operation
- 9 1 3/4" panels with wide stiles and rails for true French look



Give your home the extra touch it needs with our 200 French sliding patio doors. They feature a low-maintenance cellular PVC brick mould and water-repellent wood preservative treated exterior components that are ready to be painted. They are constructed with full-perimeter weatherstripping for a tight and consistent seal. Exterior handles come standard and a security foot bolt is also available. A selection of exterior casing options and simulated-divided-lite (SDL) provide a historically accurate look to help enhance the beauty of your home.

A



Bright brass (standard) antique brass, oil rubbed bronze or satin nickel with matching hinge and strike

B

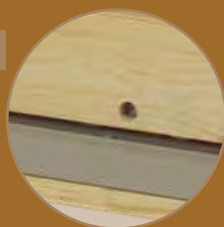

Adjustable rollers ensure smooth operation

C

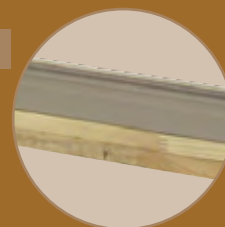

Composite sill, combines wood, aluminum and vinyl for enhanced durability



## 200 CENTER HINGED PATIO DOOR

**MW PRO SERIES 200 CENTER HINGED PATIO DOORS** deliver style and performance to any home. They are available with matching side lites, fixed panels, transoms, segmented transoms and a wide variety of architectural shapes.

# 200 CENTER HINGED PATIO DOOR



## STANDARD FEATURES

- 1 Optional multi-point locking hardware with adjustable hinge option\*
- 2 Vinyl-wrapped foam-filled full-perimeter weatherstripping for air-tight performance and smooth operation
- 3 Low-maintenance cellular PVC exterior brick mould with water-repellent preservative treated wood components are ready for acrylic latex paints
- 4 Natural wood ready for staining to match any interior décor – also available with primed interior for painting
- 5 Multi-fin door sweep on operating panel
- 6 4 9/16" jamb eliminates extensive drywall work
- 7 Standard is no bore, single bore, or dead bolt bore without hardware; handle hardware available in a variety of finishes: bright brass, antique brass, oil rubbed bronze or satin nickel interior and exterior handle sets (satin nickel shown)
- 8 Energy-efficient warm edge insulating tempered glass
- 9 Composite sill combines wood, aluminum and vinyl for enhanced durability

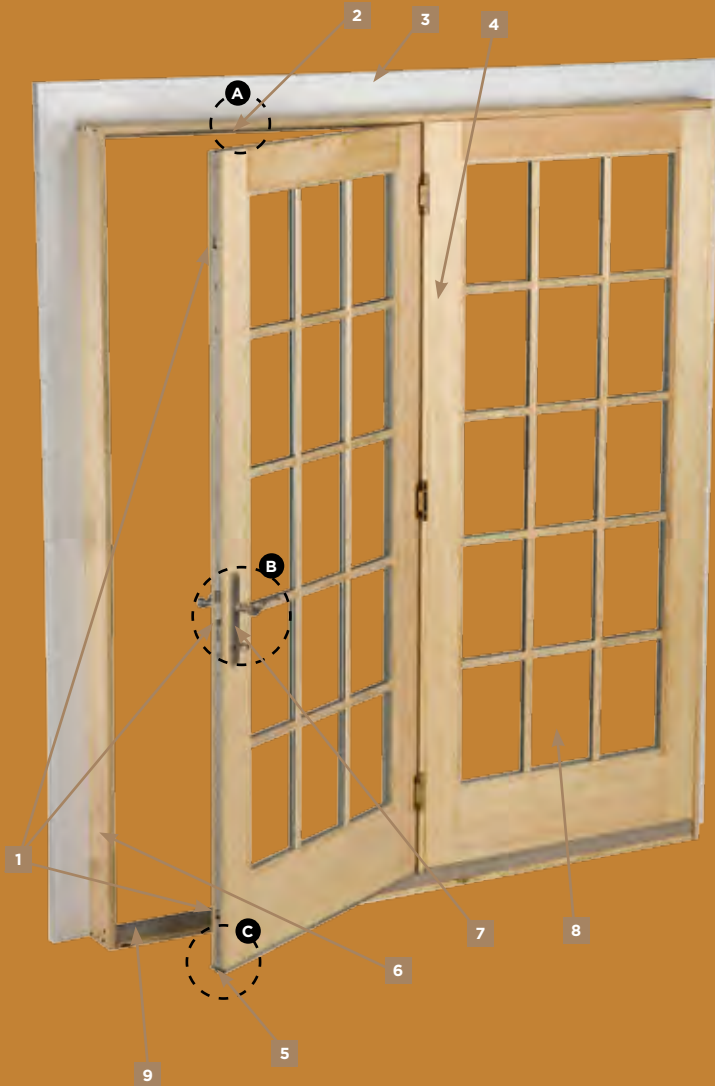

Bring out the best in your home with our 200 center hinged patio doors. They feature a low-maintenance cellular PVC brick mould and water-repellent wood preservative treated exterior components that are ready to be painted. They are constructed with full-perimeter weatherstripping for a tight and consistent seal. Exterior handles come standard. A selection of exterior casing options and simulated-divided-lite (SDL) provide a historically accurate look to help enhance the beauty of your home.

A

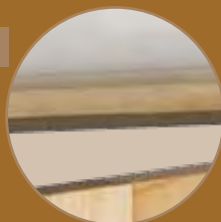

Vinyl-wrapped foam-filled full-perimeter weatherstripping for air-tight performance and smooth operation

B



Bright brass (standard), antique brass, oil rubbed bronze or satin nickel with matching hinge and strike

C



Multi-fin door sweep on operating panel

1. Available option. 2. HP glass option combines Low-E with argon gas fill for high performance.

# THERMAL PERFORMANCE DATA

## MW PRO SERIES 800 (VINYL-CLAD PRODUCTS)

## MW PRO SERIES CLASSIC (VINYL PRODUCTS)

### MW PRO SERIES 800 DOUBLE HUNG

	R Value	NFRC CERTIFIED		
		U Value	SHGC	VT
5/8" Clear	2.04	0.49	0.58	0.61
5/8" Low-E	2.70	0.37	0.28	0.52
5/8" HP Glass <sup>1</sup>	3.03	0.33	0.27	0.52

### MW PRO SERIES CLASSIC SINGLE HUNG

	R Value	NFRC CERTIFIED		
		U Value	SHGC	VT
3/4" Clear	2.08	0.48	0.61	0.64
3/4" Low-E	2.86	0.35	0.29	0.54
3/4" HP Glass <sup>1</sup>	3.23	0.31	0.28	0.54

### MW PRO SERIES 800 CASEMENT

	R Value	NFRC CERTIFIED		
		U Value	SHGC	VT
3/4" Clear	2.17	0.46	0.54	0.56
3/4" Low-E	2.94	0.34	0.25	0.48
3/4" HP Glass <sup>1</sup>	3.23	0.31	0.25	0.48

### MW PRO SERIES CLASSIC DOUBLE HUNG

	R Value	NFRC CERTIFIED		
		U Value	SHGC	VT
3/4" Clear	2.13	0.47	0.59	0.62
3/4" Low-E	2.94	0.34	0.28	0.52
3/4" HP Glass <sup>1</sup>	3.23	0.31	0.28	0.52

### MW PRO SERIES 800 AWNING

	R Value	NFRC CERTIFIED		
		U Value	SHGC	VT
3/4" Clear	2.17	0.46	0.54	0.56
3/4" Low-E	2.94	0.34	0.25	0.48
3/4" HP Glass <sup>1</sup>	3.23	0.31	0.25	0.48

### MW PRO SERIES CLASSIC CASEMENT

	R Value	NFRC CERTIFIED		
		U Value	SHGC	VT
3/4" Clear	2.33	0.43	0.54	0.55
3/4" Low-E	3.13	0.32	0.25	0.46
3/4" HP Glass <sup>1</sup>	3.45	0.29	0.24	0.46

### MW PRO SERIES 800 SLIDING PATIO DOOR

	R Value	NFRC CERTIFIED		
		U Value	SHGC	VT
3/4" Clear	2.13	0.47	0.62	0.64
3/4" Low-E	2.94	0.34	0.29	0.54
3/4" HP Glass <sup>1</sup>	3.33	0.30	0.29	0.54

### MW PRO SERIES CLASSIC AWNING

	R Value	NFRC CERTIFIED		
		U Value	SHGC	VT
3/4" Clear	2.27	0.44	0.52	0.54
3/4" Low-E	3.13	0.32	0.25	0.46
3/4" HP Glass <sup>1</sup>	3.45	0.29	0.24	0.46

### MW PRO SERIES 800 FRENCH SLIDING PATIO DOOR

	R Value	NFRC CERTIFIED		
		U Value	SHGC	VT
3/4" Clear	2.22	0.45	0.50	0.52
3/4" Low-E	2.94	0.34	0.24	0.44
3/4" HP Glass <sup>1</sup>	3.23	0.31	0.24	0.44

### MW PRO SERIES CLASSIC SLIDING WINDOW

	R Value	NFRC CERTIFIED		
		U Value	SHGC	VT
3/4" Clear	2.08	0.48	0.59	0.62
3/4" Low-E	2.86	0.35	0.28	0.53
3/4" HP Glass <sup>1</sup>	3.23	0.31	0.28	0.53

### MW PRO SERIES 800 CENTER HINGED PATIO DOOR

	R Value	NFRC CERTIFIED		
		U Value	SHGC	VT
3/4" Clear	2.22	0.45	0.47	0.49
3/4" Low-E	2.94	0.34	0.22	0.41
3/4" HP Glass <sup>1</sup>	3.13	0.32	0.22	0.41

### MW PRO SERIES CLASSIC SLIDING PATIO DOOR

	R Value	NFRC CERTIFIED		
		U Value	SHGC	VT
3/4" Clear	2.17	0.46	0.62	0.65
3/4" Low-E	3.03	0.33	0.29	0.55
3/4" HP Glass <sup>1</sup>	3.45	0.29	0.29	0.55

### MW PRO SERIES 800 FRENCH HINGED PATIO DOOR

	R Value	NFRC CERTIFIED		
		U Value	SHGC	VT
3/4" Clear	2.17	0.46	0.47	0.49
3/4" Low-E	2.86	0.35	0.23	0.41
3/4" HP Glass <sup>1</sup>	3.03	0.33	0.23	0.41

1. HP glass option combines Low-E with argon gas fill for high performance.

# THERMAL PERFORMANCE DATA

## MW PRO SERIES 400, 300 AND 200 (WOOD/COMPOSITE & WOOD PRODUCTS)

MW PRO SERIES 400 DOUBLE HUNG				
	R Value	NFRC CERTIFIED		
		U Value	SHGC	VT
3/4" Clear	2.22	0.45	0.58	0.61
3/4" Low-E	3.13	0.32	0.27	0.51
3/4" HP Glass <sup>1</sup>	3.45	0.29	0.27	0.51

MW PRO SERIES 200 CASEMENT				
	R Value	NFRC CERTIFIED		
		U Value	SHGC	VT
3/4" Clear	2.22	0.45	0.53	0.56
3/4" Low-E	3.03	0.33	0.25	0.47
3/4" HP Glass <sup>1</sup>	3.33	0.30	0.25	0.47

MW PRO SERIES 300 DOUBLE HUNG				
	R Value	NFRC CERTIFIED		
		U Value	SHGC	VT
3/4" Clear	2.17	0.46	0.61	0.63
3/4" Low-E	3.03	0.33	0.28	0.53
3/4" HP Glass <sup>1</sup>	3.45	0.29	0.28	0.53

MW PRO SERIES 200 AWNING				
	R Value	NFRC CERTIFIED		
		U Value	SHGC	VT
3/4" Clear	2.22	0.45	0.53	0.56
3/4" Low-E	3.03	0.33	0.25	0.47
3/4" HP Glass <sup>1</sup>	3.33	0.30	0.25	0.47

MW PRO SERIES 200 DOUBLE HUNG W/SDL				
	R Value	NFRC CERTIFIED		
		U Value	SHGC	VT
7/16" Clear	1.85	0.54	0.58	0.61
7/16" Low-E	2.22	0.45	0.28	0.52
7/16" HP Glass <sup>1</sup>	2.50	0.40	0.28	0.52

MW PRO SERIES 200 SLIDING PATIO DOOR				
	R Value	NFRC CERTIFIED		
		U Value	SHGC	VT
3/4" Clear	2.08	0.48	0.62	0.65
3/4" Low-E	2.94	0.34	0.29	0.55
3/4" HP Glass <sup>1</sup>	3.33	0.30	0.29	0.55

MW PRO SERIES 200 DOUBLE HUNG				
	R Value	NFRC CERTIFIED		
		U Value	SHGC	VT
5/8" Clear	2.08	0.48	0.58	0.61
5/8" Low-E	2.78	0.36	0.28	0.52
5/8" HP Glass <sup>1</sup>	3.13	0.32	0.27	0.52

MW PRO SERIES 200 FRENCH SLIDING PATIO DOOR				
	R Value	NFRC CERTIFIED		
		U Value	SHGC	VT
3/4" Clear	2.22	0.45	0.51	0.52
3/4" Low-E	2.94	0.34	0.24	0.44
3/4" HP Glass <sup>1</sup>	3.23	0.31	0.24	0.44



ENERGY STAR® Qualification Criteria WINDOWS and DOORS		
Zone	U-Factor	SHGC
Northern	≤ 0.35	ANY
North/Central	≤ 0.40	≤ 0.55
South/Central	≤ 0.40	≤ 0.40
Southern	≤ 0.65	≤ 0.40

MW PRO SERIES 200 CENTER HINGED PATIO DOOR				
	R Value	NFRC CERTIFIED		
		U Value	SHGC	VT
3/4" Clear	2.22	0.45	0.47	0.49
3/4" Low-E	2.94	0.34	0.22	0.41
3/4" HP Glass <sup>1</sup>	3.13	0.32	0.22	0.41

### ENERGY STAR CLIMATE ZONES

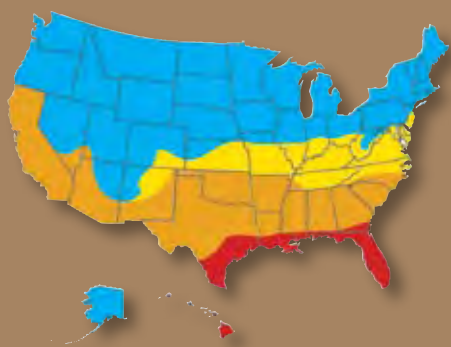

- Southern  
Mostly Cooling
- South/Central  
Cooling & Heating
- North/Central  
Heating & Cooling
- Northern  
Mostly Heating

All units are NAMI certified and rated in accordance with NFRC 100/200 standards by an AAMA accredited lab. Performance values reflect the performance of units tested with the following configuration: 3mm glass, no grilles and IGU thickness specified in the chart.

R VALUE: Restrictive ambient air flow  
U VALUE: Rate of heat loss  
SHGC: Solar Heat Gain Coefficient  
VT: Visible Transmittance

## GLASS OPTIONS

- Low-E
  - HP Glass  
(Low-E/Argon)
  - Low-E/Tinted
  - Obscure
  - Tinted
  - Laminated  
(security)
  - Tempered\*
- \* Tempered glass is standard on Sliding Patio Doors

## SCREENS

Pro Series screens feature white aluminum frames with fiberglass mesh. Screens for single hung units are half-length while screens for double hung, casement, awning and slider windows are full-length. Sliding patio door screens are full-length and feature steel rollers for ease of operation.

## WHAT IS LOW-E?

It is a microscopically thin, virtually invisible metallic oxide layer deposited on a window glazing surface. Low-E can reduce heating and cooling bills while dramatically improving overall comfort.

Ply Gem Windows and Patio Doors with the High Performance Low-E glazing system can be configured to meet the ENERGY STAR® guidelines for thermal efficiency in all climate regions.



## CLASSIC VINYL IMPACT WINDOWS & DOORS



- **Single hung windows** are constructed to meet DP50 performance.
- **Casement windows** feature corrosion-resistant coastal hardware and are constructed to meet DP60 performance.
- **Sliding patio doors** feature corrosion-resistant coastal hardware and are constructed to meet DP50 performance.
- **Architectural shape windows** are constructed to meet DP50 performance.
- Rated in accordance with the International Residential Codes and meet impact requirements in U.S. Zone 2 (110-120 mph) and Zone 3 (120-140 mph).
- Passes ASTM E1886/1996 Large Missile Impact and Cycling Tests.
- Meets AAMA/WDMA/CSA 101/I.S.2/A440 standard. Florida Building Commission Approved.
- Meets wind-borne debris specifications for large missile D (8' missile for Impact Zone 3 at 50 ft/sec) and small missile C (4' missile for Impact Zone 2 at 40'/sec)



# COLOR OPTIONS



	INT.	EXT.	INT.	EXT.	EXTERIOR	INT.	EXT.	INTERIOR
800 Double Hung	●	●			●			●
800 Casement & Awning	●	●			●			●
800 Sliding Patio Doors		●			●			●
800 French Sliding Patio Doors		●			●			●
800 Center Hinged Patio Doors		●			●			●
800 French Hinged Patio Doors		●			●			●
Classic Single Hung	●	●	●	●				
Classic Double Hung	●	●	●	●				
Classic Casement & Awning	●	●	●	●				
Classic Sliding Windows	●	●	●	●				
Classic Sliding Patio Doors	●	●	●	●				
400 Double Hung‡	●	●						
300 Double Hung*	●	●	●	●				
200 Double Hung**						●	●	●
200 Casement & Awning**						●	●	●
200 Sliding Patio Doors**						●	●	●
200 French Sliding Patio Doors**						●	●	●
200 Center Hinged Patio Doors**						●	●	●

Colors shown may not be accurate representations. For color matching, please request color swatches from your Ply Gem sales representative.

\* 300 double hung colors indicate the color of the all-vinyl sash. The all-vinyl sash must not be painted. The exterior casing and other interior exposed surfaces are constructed from cellular PVC components that are ready to accept acrylic latex paint.

\*\* 200 windows and doors feature PVC exterior components with water-repellent preservative treated wood sash and door panels primed on the exterior.

‡ 400 double hung units are constructed from cellular PVC components that are ready to accept acrylic latex paint.

# HARDWARE OPTIONS

## Hardware and Finish Options for 200 and 800 Patio Door



## Classic Patio Door Hardware and Finish Options



## Exterior Handle Colors for 200 Series Standard Sliding Door



\* Handles shown with keyed lock option.

# EXTERIOR CASING OPTIONS FOR MW PRO 400, 300 AND 200 SERIES

# STANDARD GRILLE PATTERNS



180 Brick Mould

3 1/4" Williamsburg

4 1/2" Wide Back Band



3 1/2" Flat (also in 5 1/2")

Standard Sill Nose

Bull Sill Nose

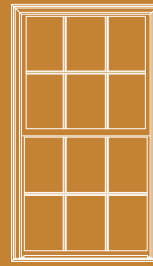

Colonial

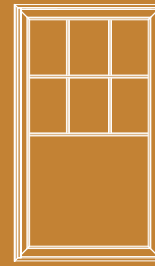

Half Colonial (shown on Casement)

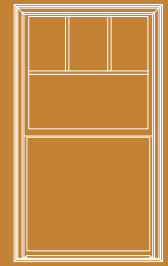

Plaza

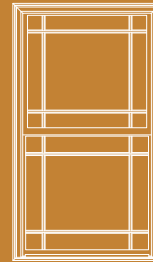

Prairie

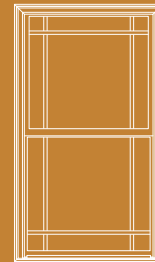

Perimeter Prairie

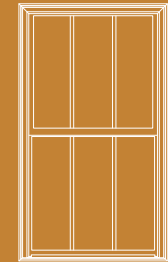

Three over Three

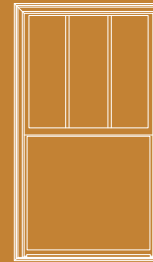

Three over One

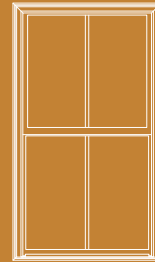

Two over Two

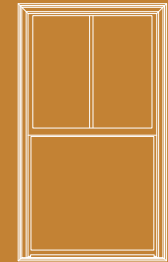

Two over One

Call customer service for optional grille patterns (800.999.8400)

## EXTENSION JAMBS

### MW PRO SERIES 800

Available in primed or natural "clear" wood custom from 4 9/16" to 6 9/16" on doors and 8 9/16" on windows

### MW PRO SERIES CLASSIC

Available in primed or natural "clear" wood custom from 4 9/16" to 6 9/16" on doors and 8 9/16" on windows

### MW PRO SERIES 400, 300 AND 200

Available in primed or natural "clear" wood custom from 4 9/16" to 6 9/16" on doors and 8 9/16" on windows

## GRILLE STYLES

### ALL OPTIONS FOR MW PRO 800, 400, 300 AND 200 SERIES OPTIONS FOR MW PRO CLASSIC SERIES



5/8" Flat GBG



7/8" Flat GBG



5/8" Sculptured GBG



1" Contoured GBG



7/8" SDL<sup>1</sup>



1 1/4" SDL<sup>1</sup>



5/8" Removable Grilles<sup>2</sup>



1 1/16" Removable Grilles<sup>2</sup>

1. SDL available on MW Pro 400 windows in white cellular PVC; MW Pro 300 windows in color coordinated cellular PVC; MW Pro 200 windows and doors in exterior white cellular PVC with wood interior. 2. Available on MW Pro 800, 400 and 200 Series.

GBG = Grilles-Between-the-Glass  
SDL = Simulated-Divided-Light



## ARCHITECTURAL SHAPES

